

AUTOOL[®]

AUTOOL TN201

Digital Sound Level Meter

User Manual

用户手册

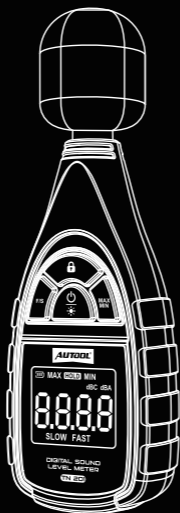

www.autooltech.com

TABLE OF CONTENTS

Copyright Information	2
Copyright.....	2
Trademark	2
Precaution	3
Product Overview	3
Product Parameters	4
Product Structure	4
Structural Diagram.....	4
Interface Display.....	5
Operating Instructions	6
Battery Installation	6
Power On/Off	6
Function Description.....	6
Maintenance Service	8
Maintenance	8
Warranty	9
Warranty access	9
Disclaimer	9
Return & Exchange Service	10
Return & Exchange.....	10

COPYRIGHT INFORMATION

Copyright

- All rights reserved by AUTOOL TECH. CO., LTD. No part of this publication may be reproduced, stored in a retrieval system, or transmitted in any form or by any means, electronic, mechanical, photocopying, recording or otherwise, without the prior written permission of AUTOOL. The information contained herein is designed only for the use of this unit. AUTOOL is not responsible for any use of this information as applied to other units.
 - Neither AUTOOL nor its affiliates shall be liable to the purchaser of this unit or third parties for damages, losses, costs, or expenses incurred by the purchaser or third parties as a result of: accident, misuse, or abuse of this unit, or unauthorized modifications, repairs, or alterations to this unit, or failure to strictly comply with AUTOOL operating and maintenance instructions.
 - AUTOOL shall not be liable for any damages or problems arising from the use of any options or any consumable products other than those designated as original AUTOOL products or AUTOOL approved products by AUTOOL.
 - Other product names used herein are for identification purposes only and may be trademarks of their respective owners. AUTOOL disclaims any and all rights in those marks.
-

Trademark

- Manual are either trademarks, registered trademarks, service marks, domain names, logos, company names or are otherwise the property of AUTOOL or its affiliates. In countries where any of the AUTOOL trademarks, service marks, domain names, logos and company names are not registered, AUTOOL claims other rights associated with unregistered trademarks, service marks, domain names, logos, and company names. Other products or company

names referred to in this manual may be trademarks of their respective owners. You may not use any trademark, service mark, domain name, logo, or company name of AUTOOL or any third party without permission from the owner of the applicable trademark, service mark, domain name, logo, or company name. You may contact AUTOOL by visiting AUTOOL at <https://www.autooltech.com>, or writing to aftersale@autooltech.com, to request written permission to use materials on this manual for purposes or for all other questions relating to this manual.

PRECAUTION

- ▶ Execute proper operations according to the provided instructions. Use the instrument in environments specified within the technical parameters table.
- ▶ Avoid storing or operating the instrument in environments with high temperatures, high humidity, flammable substances, explosive elements, or strong electromagnetic fields.
- ▶ Shield the instrument from corrosive chemicals. When cleaning the outer shell, opt for a neutral cleaning agent.
- ▶ Resist the temptation to disassemble the instrument without proper authorization.

PRODUCT OVERVIEW

- Presenting this AUTOOL TN201 digital sound level meter tailored for noise measurement, applicable to diverse settings such as noise engineering, health prevention, and environmental noise assessments. Ideal for measuring noise in automotive repair facilities, factories, traffic areas, and home audio environments.
-



Product Parameters

Measurement range	30~130dB (A-weighted)
Resolution	0.1dB
Accuracy	±1.5dB (Reference sound pressure standard, 94dB @ 1kHz)
Response frequency	31.5Hz~8kHz
Time weighting characteristics	Fast (125 milliseconds time constant); Slow (1 second time constant)
Operating environment	Temperature: 0~40°C; Humidity: ≤80%RH
Power supply	3 AAA x 1.5V alkaline batteries
Protection level	IP40
Housing material	ABS

PRODUCT STRUCTURE

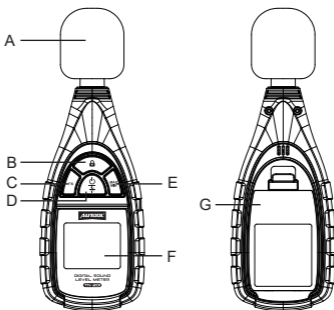
Structural Diagram



A	Windproof sponge ball (Removable for Capacitive Microphone)	
B	[]Data hold	
C	[F/S]Time weighted switching	
D	[]Power on/off, backlight switching	
E	[]Maximum/minimum value measurement switching	
F	LCD screen	G Battery compartment

Interface Display

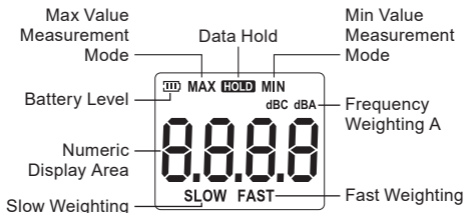

OPERATING INSTRUCTIONS

Battery Installation

- Observe the positive (+) and negative (-) indicators inside the battery compartment. Then insert the batteries accordingly.
 - Close the battery cover securely.
 - If the instrument displays [] indicating low battery, replace the batteries promptly.
 - When not using the instrument for an extended period, remove the batteries and store them properly.
-

Power On/Off

- Long press [] button to turn the instrument on or off.

Note:

- ▶ The instrument will automatically shut down after 10 minutes of inactivity by default.
-

Function Description

- **Backlight**

Press the [] button to turn the screen backlight on or off.

- **Time Weighting**

Press [**F/S**] button to switch between fast weighting (FAST) or slow weighting (SLOW).

1.Fast Weighting (FAST):

Time constant of 125 milliseconds, displays the current instantaneous noise value. Typically used for measuring fluctuating, non-stationary noise, and transportation noise.

2.Slow Weighting (SLOW):

Time constant of 1 second, displays the average noise value within the current 1-second interval. Generally used for measuring steady-state noise.

- **Measurement Mode**

Press [] button to switch between min value, max value, or normal value measurement.

In min and max value measurement modes, the instrument will hold the minimum or maximum value until a smaller or larger value is measured.

Note:





► The instrument defaults to normal value measurement mode upon startup.

• **Data Hold**

Press [] button to toggle the data hold function on or off. When activated, the numeric value remains locked.

• **Auto Shutdown Setting**





The instrument allows setting an auto shutdown time between 0 to 120 minutes. If there is no button operation within the set time, the instrument will automatically shut down.

To set the auto shutdown time after powering on, press and hold [] button, then long-press [] button for about 2 seconds. The instrument enters the time setting interface. Use [F/S] and [] buttons to adjust the numerical value (setting to 0 means no auto shutdown). After setting, press [] to save and exit.

Note:

► In the setting interface, if there is no operation for about 20 seconds, the instrument will return to the measurement interface. You can press [] button at any time to exit during the setting process.

• **Restore Factory Settings**

To restore factory settings, press and hold [] button, then long-press [] button for about 2 seconds. The instrument enters the time setting interface. Afterward, press and hold [] button, then long-press [] button for about 10 seconds to restore factory settings.

MAINTENANCE SERVICE

- Our products are made of long-lasting and durable materials, and we insist on perfect production process. Each product leaves the factory after 35 procedures and 12 times of testing and inspection work, which ensures that each product has excellent quality and performance.
-

Maintenance

To maintain the performance and appearance of the product, it is recommended that the following product care guidelines be read carefully:

- Be careful not to rub the product against rough surfaces or wear the product, especially the sheet metal housing.
- Please regularly check the product parts that need to be tightened and connected. If found loose, please tighten it in time to ensure the safe operation of the equipment. The external and internal parts of the equipment in contact with various chemical media should be frequently treated with anti-corrosion treatment such as rust removal and painting to improve the corrosion resistance of the equipment and extend its service life.
- Comply with the safe operating procedures and do not overload the equipment. The safety guards of the products are complete and reliable.
- Unsafe factors are to be eliminated in time. The circuit part should be checked thoroughly and the aging wires should be replaced in time.
- Regularly clean and replace consumable parts such as oil pump and oil filter; adjust the clearance of various parts and replace worn (broken) parts. Avoid contact with corrosive liquids.
- When not in use, please store the product in a dry place. Do not store the product in hot, humid, or non-ventilated places.

WARRANTY

- From the date of receipt, we provide a three-year warranty for the main unit and all the accessories included are covered by a one-year warranty.
-

Warranty access

- The repair or replacement of products is determined by the actual breakdown situation of product.
- It is guaranteed that AUTOOL will use brand new component, accessory or device in terms of repair or replacement.
- If the product fails within 90 days after the customer receives it, the buyer should provide both video and picture, and we will bear the shipping cost and provide the accessories for the customer to replace it free of charge. While the product is received for more than 90 days, the customer will bear the appropriate cost and we will provide the parts to the customer for replacement free of charge.

These conditions below shall not be in warranty range

- The product is not purchased through official or authorized channels.
- The product breakdown because the user does not follow product instructions to use or maintain the product.

We AUTOOL pride ourselves on superb design and excellent service. It would be our pleasure to provide you with any further support or services.

Disclaimer

- All information, illustrations, and specifications contained in this manual, AUTOOL reserves the right of modify this manual and the machine itself with no prior notice. The physical appearance and color may differ from what is shown in the manual, please refer to the actual product.

Every effort has been made to make all descriptions in the book accurate, but inevitably there are still inaccuracies, if in doubt, please contact your dealer or AUTOOL after-service centre, we are not responsible for any consequences arising from misunderstandings.

RETURN & EXCHANGE SERVICE

Return & Exchange

- If you are an AUTOOL user and are not satisfied with the AUTOOL products purchased from the online authorized shopping platform and offline authorized dealers, you can return the products within seven days from the date of receipt; or you may exchange it for another product of the same value within 30 days from the date of delivery.
- Returned and exchanged products must be in fully saleable condition with documentation of the relevant bill of sale, all relevant accessories and original packaging.
- AUTOOL will inspect the returned items to ensure that they are in good condition and eligible. Any item that does not pass inspection will be returned to you and you will not receive a refund for the item.
- You can exchange the product through the customer service center or AUTOOL authorized distributors; the policy of return and exchange is to return the product from where it was purchased. If there are difficulties or problems with your return or exchange, please contact AUTOOL Customer Service.

China	400-032-0988
Oversea Zone	+86 0755 23304822
E-mail	aftersale@autooltech.com
Facebook	https://www.facebook.com/autool.vip
YouTube	https://www.youtube.com/c/autooltech

目录

版权信息	12
版权	12
注册商标	12
注意事项	13
产品简介	13
技术参数	13
产品结构	14
结构图	14
界面展示	14
操作说明	15
电池安装	15
开关机	15
功能说明	15
维修保养服务	17
维修保养	17
保修服务	18
保修方式	18
声明	18
退换货服务	19
退换货	19

版权信息

版权

- 版权所有!未征得深圳市偶然科技有限公司的书面同意,任何公司或个人不得以任何形式(电子、机械、影印、录制或其他形式)对本说明书进行复制和备份。本手册专为偶然公司产品的使用而计,对于将之用于指导其他设备操作而导致的各种后果,本公司不承担任何责任。
 - 因使用者个人或第三方的意外事故,滥用、误用该设备,擅自更改,或修理该设备,或未按偶然公司的操作与保养要求而导致设备损坏、遗失所产生的费用及开支等,偶然公司及其分支机构不承担任何责任。
 - **正式声明:**本说明书所提及之其他产品名称,目的在于说明该设备如何使用,其注册商标所有权仍属原公司。
 - 本设备供专业技术人员或维修人员使用。
-

注册商标

- 偶然公司已在中国及海外若干国家进行了商标注册,其标志为 **AUTOTOL**。本手册所提及之偶然公司其它商标、服务标志、域名、图标、公司名称均属偶然及其下属公司之产权。在偶然公司之商标、服务标志、域名、图标、公司名称还未注册之国家,偶然公司声明其对未注册商标、服务标志、域名、图标、公司名称之所有权。本手册所提及之其它产品及公司名称的商标仍属于原注册公司所有。在未得到拥有人的书面同意之前,任何人不得使用偶然公司或所提及的其它公司之商标、服务标志、域名、图标、公司名称。
- 您可以访问偶然网址:www.autooltech.com,或发送邮件至:aftersale@autooltech.com,与偶然公司进行联系,征得其手册使用权之书面同意。

注意事项

- ▶ 请正确操作仪器，并在技术参数表限定的环境中使用。
- ▶ 请勿在高温、高湿、易燃、易爆和强电磁环境中存放或使用仪器。
- ▶ 避免仪器接触腐蚀性化学物质。如需清洁仪器外壳，请使用中性清洁剂。
- ▶ 禁止私自拆卸仪器。

产品简介

- AUTOOL TN201 是一款测量噪音的仪器，可用于噪音工程、健康防治及其他环境噪音测量，如汽车维修场所、工厂、交通道路、家庭音响等场合的噪音测量。





技术参数

测量范围	30~130dB(A计权)
分辨率	0.1dB
精度	±1.5dB(参考音压标准, 94dB@1kHz)
响应频率	31.5Hz~8kHz
时间计权特性	快速FAST(时间常数为125毫秒); 慢速SLOW(时间常数为1秒)
操作环境	温度: 0~40°C; 湿度: ≤80%RH
电源	3节7号1.5V碱性电池
防护等级	IP40
外壳材质	ABS

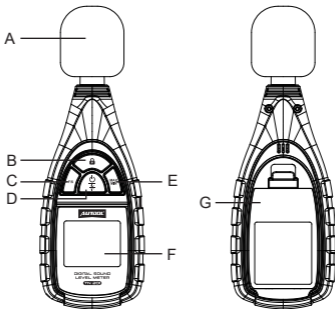
产品结构

结构图



A	防风海绵球 (取下可见电容麦克风)	
B	[] 数值锁定	
C	[] 时间计权切换	
D	[] 开关机、背光切换	
E	[] 最大/最小值测量切换	
F	液晶显示屏	G 电池仓

界面展示



操作说明

电池安装

- 按电池仓内部正负极指示装入电池。
 - 装入电池后, 请盖上电池盖。
 - 仪器提示[]时, 表示电池电量过低, 需及时更换电池。
 - 长时间不使用仪器时, 请务必将电池取出并妥善放置。
-

开关机

- 长按[]键, 仪器开启或关闭。

注:

- ▶ 仪器默认10分钟无按键操作, 自动关机。
-

功能说明

• 背光

点按[]键, 仪器开启或关闭屏幕背光。

• 时间计权

点按[**F/S**]键, 可切换快速计权(FAST)或慢速计权(SLOW)。

1)快速计权(FAST): 时间常数为125毫秒, 显示当前即时噪音值, 一般用于测量波动较大的不稳态噪音和交通运输噪音等。

2)慢速计权(SLOW): 时间常数为1秒, 显示当前1秒内平均噪音值, 一般用于测量稳态噪音。

• 测量模式

点按[]键, 可切换最小值、最大值或正常值测量。在最小值和最大值测量模式下, 仪器将保持最小或最大值不变, 除非测到更小或更大的数值。

注:





- ▶ 仪器开机, 默认进入正常值测量模式。

• 数值锁定

点按[]键，仪器开启或关闭数值锁定功能。开启后，数值锁定不变。

• 自动关机设置





仪器可设置0~120分钟自动关机时间，设置时间内无按键操作，仪器自动关机。

开机后，先长按住[]键不放，再长按[]键约2秒，仪器进入时间设置界面。此时，点按[F/S]和[]键可调整数值大小（数值为0时，仪器不会自动关机），设置完成后点按[]键保存并退出。

注：

- ▶ 设置界面下，约20秒无任何操作，仪器返回测量界面。
- ▶ 设置过程中，可随时按[]键退出。

• 恢复出厂设置

先长按住[]键不放，再长按[]键约2秒，仪器进入时间设置界面，然后长按住[]键不放，再长按[]键约10秒仪器恢复出厂设置。

维修保养服务

- 您所拥有的AUTOOOL产品选用持久耐用的材料，AUTOOOL坚持精益求精的生产工艺，每一件产品出厂都经过35道工序及12次质检工作，从而确保每一件产品都拥有卓越的品质及性能。所以您的AUTOOOL产品值得您定期维护保养，使其将能够长期稳定地工作。
-

维修保养

维护保养是为了保持产品性能和外观，我们建议您仔细阅读以下产品保养指南：

- 注意不要将产品与粗糙表面摩擦或揉搓产品，特别是钣金外壳。
- 对产品中需要紧固和连接的部位经常进行检查，如发现松动应及时紧固，以保证产品的安全运行。对与各种化学介质接触的产品外部和内部零件要经常进行除锈、喷漆等防腐处理，以提高产品的抗腐蚀能力，延长产品的使用寿命。
- 遵守安全操作规程，不超负荷使用产品。产品的安全防护装置齐全可靠，及时消除不安全因素。电路部分彻底检查，老化电线要及时更换。
- 定期清洗和更换油泵、滤油器等易耗部件；调整各部位配合间隙和更换磨损（已坏）部件清洁时，避免产品接触带腐蚀性的液态物品。
- 不使用时，请将产品存放于干燥的位置。不要将产品存放在高温、潮湿或不通风的地方。

保修服务

- AUTOOL主机自客户签收日起享有3年保修期。其所含附件自客户签收日起享有1年保修期。
-

保修方式

- 根据具体的故障情况对产品进行免费修理或更换；
- 我方保证所有更换的部件、附件或产品都是全新；
- 在客户收到产品90天内出现故障同时提供视频和图片，我方承担运费并免费提供相应配件给客户更换。收到产品超过90天，客户承担相应的费用，我方免费提供配件给客户更换；

以下情况不在免费保修范围：

- 非正规渠道购买AUTOOL的产品；
- 未按产品说明书要求使用和维护造成的损坏；

在AUTOOL，我们为精湛的设计和卓越的服务感到自豪。我们很乐意为您提供更多的支持或服务。

声明

- 偶然公司保留更改产品设计与规格的权利，届时恕不另行通知。实物外观与颜色可能与说明书中显示的有差别，请以实物为准。我们已尽最大努力力求使书中所有描述准确，但仍难免有不妥之处。如有疑问，请联系经销商或偶然售后服务中心。本公司对产品拥有最终解释权，不承担任何因误解而产生的后果。

退换货服务

退换货

- 如果您对从线上授权购物平台和线下授权经销商所购买的AUTOOL产品不满意，根据《AUTOOL全球销售条款》，您可以自收到产品之日起七日内退货；或者在产品交付之日起的30日内调换等值的其他产品。
- 退回及调换的产品必须处于完全可销售状态，并附上相关销售单单据，所有相关配件、纸质发票（如有）。
- AUTOOL将会对寄回退货的商品进行检查，以确保其处于完好无损的状态并且符合条件，相关条件详情请参阅《AUTOOL全球销售条款》。任何未通过检查的商品将退还给您，您将不会获得商品退款。
- 您可以通过客户服务中心或AUTOOL授权经销商调换产品；退换货原则为从哪里购买，就从哪里退换货。如果您退换货遇见困难或者阻碍，请联系AUTOOL客户服务中心。通过客户服务中心退换货时，我们建议您通过下面的方式进行：

中国区域致电	400-032-0988 / 18929303778
售后微信号	18929303778
海外区域致电	+86 0755 23304822
E-mail	aftersale@autooltech.com
Facebook	https://www.facebook.com/autool.vip
YouTube	https://www.youtube.com/c/autooltech

- 如您的退换货得到确认，您将收到确认信息和邮件。



深圳市偶然科技有限公司

广东省深圳市宝安区航城锦驰产业园

📍 Hangcheng Jincheng Industrial Park, Bao'an, Shenzhen, China

🌐 www.autooltech.com

✉ aftersale@autooltech.com

☎ +86-755-2330 4822 / +86-400 032 0988



执行标准 / Execution Standard: GB/T14623-93